

# Index

Fiberglas	04
Fiberglas Hochglanz	06
Hartholz FSC	08
Galvanisierter Stahl	10
CorTen Stahl	12
Aluminium	14
Burni Feuelemente	16
Accessoires Burni	24
Wasserelemente	26
Polymerbeton	30
Blockwände CorTen	36
Sockel	38
Wände CorTen Stahl	40
Wände Fiberglas	42
Briefkästen	44
CorTen Treppen	46
Beeteinfassungen	48
Accessoires	50



Material  
3 mm

Standard  
Farbe  
RAL 7021

## Fiberglas

**Fiberglas** Unsere Fiberglasplantzgefäße werden aus hochwertigem faserverstärktem Fiberglas hergestellt. Besonderes Augenmerk legen wir auf zusätzlich verstärkte Ecken und bei allen kubischen Formen auf eine Dämmung mit Polystyrol. Der doppelt umgelegte Rand verleiht dem Gefäß zusätzliche Stabilität und eine körperhafte Optik. Als Standardfarbe verwenden wir **RAL 7021** schwarzgrau. Weitere lieferbare RAL-Farben: **2004 | 3020 | 4004 | 7006 | 7016 | 7035 | 8024 | 9005 | 9010**. Wir empfehlen die Gefäße mindestens zweimal im Jahr mit unserem Polyester Pflege-Set zu reinigen (Siehe Zubehör). Verwenden Sie bitte keinen Hochdruckreiniger und keine scheuernden oder lösungsmittelhaltigen Reinigungsmittel, da die Gefäße sonst beschädigt werden können.



Buxus

Buxus

Buxus

Acer

Canna

Ceder

Bellis

Malva.

				KG
<b>Buxus PB1</b>	2000	2000	600 mm	49
<b>Buxus PB2</b>	1600	1600	600 mm	36
<b>Buxus PB3</b>	1400	1400	600 mm	30
<b>Buxus PB5</b>	1200	1200	1000 mm	34
<b>Buxus PB6</b>	1200	1200	800 mm	29
<b>Buxus PB7</b>	1200	1200	600 mm	24
<b>Buxus PB8</b>	1200	1200	400 mm	19
<b>Buxus PB9</b>	1000	1000	1000 mm	27
<b>Buxus PB10</b>	1000	1000	800 mm	23
<b>Buxus PB11</b>	1000	1000	600 mm	19
<b>Buxus PB12</b>	1000	1000	400 mm	15
<b>Buxus PB13</b>	800	800	800 mm	18
<b>Buxus PB13.1</b>	800	800	600 mm	14
<b>Buxus PB14</b>	700	700	700 mm	14
<b>Buxus PB15</b>	600	600	600 mm	10
<b>Buxus PB16</b>	500	500	500 mm	7
<b>Buxus PB17</b>	400	400	400 mm	4
<b>Buxus PB18</b>	500	500	1000 mm	12
<b>Buxus PB19</b>	400	400	1200 mm	11
<b>Buxus PB20</b>	400	400	1000 mm	9
<b>Buxus PB21</b>	400	400	800 mm	8
<b>Buxus PB22</b>	2000	500	600 mm	22
<b>Buxus PB23</b>	1500	500	600 mm	17
<b>Buxus PB24</b>	1200	500	600 mm	14
<b>Buxus PB24.1</b>	900	500	600 mm	11
<b>Buxus PB25.1</b>	1500	250	800 mm	18
<b>Buxus PB25</b>	900	250	800 mm	11
<b>Buxus PB26</b>	1000	500	500 mm	11
<b>Buxus PB27.1</b>	1500	400	400 mm	12
<b>Buxus PB27</b>	1000	400	400 mm	8
<b>Buxus PB28</b>	2300	500	400 mm	19

			KG
<b>Acer PE1.1</b>	1500	800 mm	20
<b>Acer PE1</b>	1200	800 mm	13
<b>Acer PE2</b>	950	700 mm	9
<b>Acer PE3</b>	890	1000 mm	11
<b>Acer PE4</b>	630	520 mm	5
<b>Acer PE5</b>	550	760 mm	5

<b>Canna PC1</b>	500	590 mm	4
<b>Canna PC2</b>	500	900 mm	6
<b>Canna PC3</b>	720	840 mm	8
<b>Canna PC4</b>	800	1000 mm	11
<b>Canna PC5</b>	1000	950 mm	12
<b>Canna PC6</b>	700	1120 mm	11

<b>Ceder PD1</b>	2000	400 mm	17
<b>Ceder PD2</b>	1530	340 mm	12
<b>Ceder PD3</b>	1200	400 mm	9

<b>Bellis PJ1</b>	1500	600 mm	25
<b>Bellis PJ2</b>	1200	600 mm	18

<b>Malva PM1</b>	1200	200 mm	7
<b>Malva PM2</b>	2000	400 mm	18

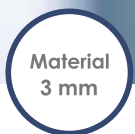

## Fiberglas Hochglanz

**Fiberglas** Unsere Fiberglasplantzgefäße werden aus hochwertigem faserverstärktem Fiberglas hergestellt. Besonderes Augenmerk legen wir auf zusätzlich verstärkte Ecken und bei allen Kubischen Formen auf eine Dämmung mit Polystyrol. Der doppelt umgelegte Rand verleiht dem Gefäß zusätzliche Stabilität und eine körperhafte Optik. Als Standardfarbe verwenden wir **RAL 9010** weiß. Weitere lieferbare RAL-Farben: **2004 | 3020 | 4004 | 7006 | 7016 | 7035 | 8024 | 9005 | 7021**. Wir empfehlen die Gefäße mindestens zweimal im Jahr mit unserem Polyester Pflege-Set zu reinigen (Siehe Zubehör). Verwenden Sie bitte keinen Hochdruckreiniger und keine scheuernden oder lösungsmittelhaltigen Reinigungsmittel, da die Gefäße sonst beschädigt werden können.





**Buxus**





**Buxus**



**Canna**

				KG
<b>Buxus PBH10</b>	1000	1000	800 mm	23
<b>Buxus PBH11</b>	1000	1000	600 mm	19
<b>Buxus PBH13</b>	800	800	800 mm	18
<b>Buxus PBH14</b>	700	700	700 mm	14
<b>Buxus PBH15</b>	600	600	600 mm	10
<b>Buxus PBH20</b>	400	400	1000 mm	9
<b>Buxus PBH21</b>	400	400	800 mm	8
<b>Buxus PBH24</b>	1200	500	600 mm	14

			KG
<b>Canna PCH1</b>	500	590 mm	4
<b>Canna PCH2</b>	500	900 mm	6
<b>Canna PCH3</b>	720	840 mm	8
<b>Canna PCH4</b>	800	1000 mm	11
<b>Canna PCH6</b>	700	1120 mm	11

Hartholz FSC

Material  
22 mm



Fuß  
Valencia  
90 mm

Fuß  
Sevilla  
20 mm

## Hartholz FSC

**Hartholz FSC** Wir verarbeiten nur tropisches Hartholz mit FSC-Zertifizierung, das legal gefällt würde und zur Dauerhaftigkeitsklasse 1 zählt. Durch die Verwendung von Hartholz schaffen wir nachhaltige Produkte mit einer natürlichen, warmen Ausstrahlung. Aufgrund der hohen Dauerhaftigkeitsklasse ist keine Behandlung notwendig. Alle Befestigungsmaterialien sind aus Edelstahl, die Innenseiten sind mit Antiwurzeltuch verkleidet. Bei einigen Modellen sind Maßanfertigungen möglich.



Valencia



Valencia



Sevilla Taper



Sevilla



Sevilla Heckenkasten

				KG
<b>Valencia HR1</b>	1200	1200	950 mm	109
<b>Valencia HR2</b>	1000	1000	950 mm	87
<b>Valencia HR3</b>	800	800	800 mm	52
<b>Valencia HR4</b>	600	600	600 mm	29

<b>Valencia HR5</b>	2000	500	600 mm	65
<b>Valencia HR6</b>	1500	500	600 mm	48
<b>Valencia HR7</b>	1200	500	600 mm	38

<b>Sevilla HS1</b>	1400	1400	740 mm	114
<b>Sevilla HS2</b>	1200	1200	740 mm	93
<b>Sevilla HS3</b>	1000	1000	740 mm	74
<b>Sevilla HS4</b>	800	800	740 mm	56
<b>Sevilla HS5</b>	600	600	620 mm	34
<b>Sevilla HS6</b>	2000	500	620 mm	75
<b>Sevilla HS7</b>	1500	500	620 mm	64
<b>Sevilla HS8</b>	1200	500	620 mm	49

<b>Sevilla Taper H05</b>	700	700	980 mm	57
<b>Sevilla Taper H06</b>	600	600	860 mm	42
<b>Sevilla Taper H07</b>	550	550	740 mm	33
<b>Sevilla Taper H08</b>	500	500	620 mm	25

<b>Heckenkasten HH1</b>	2660	450	380/2220 mm	112
<b>Heckenkasten HH2</b>	1360	450	380/2220 mm	68



Fuß  
90 mm



Material  
4 mm



## Galvanisierter Stahl

**Galvanisierter Stahl** Feuerverzinkung ist eine Form der Galvanisierung. Stahl wird nach entsprechender Vorbehandlung in ein ca. 460 °C heißes Zinkbad getaucht. An der Stahloberfläche bildet sich eine graue, kräftige Eisen-Zink-Legierung, die den Stahl über Jahrzehnte vor Korrosion schützt. Durch einen weiteren Prozess bekommen unsere Gefäße einen charmanten, verwitterten Ausdruck.



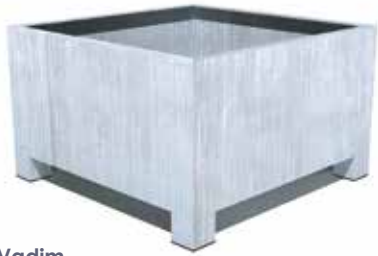

Vadim



Vadim

				KG
<b>Vadim VS1</b>	1400	1400	800 mm	215
<b>Vadim VS2</b>	1200	1200	800 mm	172
<b>Vadim VS4</b>	1000	1000	800 mm	139
<b>Vadim VS5</b>	800	800	800 mm	109
<b>Vadim VS7</b>	600	600	600 mm	60

<b>Vadim VS9</b>	2000	500	600 mm	130
<b>Vadim VS10</b>	1500	500	600 mm	105
<b>Vadim VS11</b>	1200	500	600 mm	89

CorTen Stahl



### CorTen Stahl

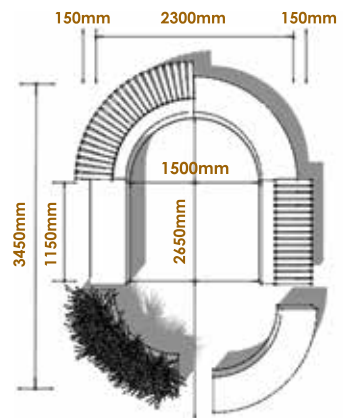

Carva



Andes



Cado



Celso



Atlas





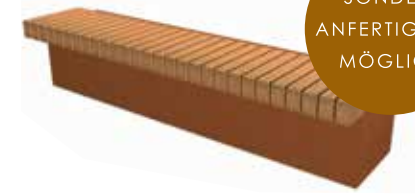



Carpa





Carpa mit Padouk Sitzelement

SONDER-  
ANFERTIGUNG  
MÖGLICH

				KG
<b>Andes CA1</b>	1400	1400	800 mm	112
<b>Andes CA2</b>	1200	1200	800 mm	93
<b>Andes CA3</b>	1000	1000	1000 mm	89
<b>Andes CA4</b>	1000	1000	800 mm	75
<b>Andes CA4.1</b>	1000	1000	600 mm	60
<b>Andes CA5</b>	800	800	800 mm	54
<b>Andes CA5.1</b>	800	800	600 mm	44
<b>Andes CA6</b>	700	700	700 mm	42
<b>Andes CA7</b>	600	600	600 mm	31
<b>Andes CA8</b>	500	500	500 mm	22
<b>Andes CA9</b>	2000	500	600 mm	69
<b>Andes CA10</b>	1500	500	600 mm	54
<b>Andes CA11</b>	1200	500	600 mm	45
<b>Andes CA12</b>	900	300	800 mm	37
<b>Andes CA13</b>	500	500	1000 mm	38
<b>Andes CA14</b>	400	400	1000 mm	30
<b>Andes CA15</b>	400	400	800 mm	25
<b>Andes CA16</b>	400	400	400 mm	15
<b>Andes CA17</b>	300	300	600 mm	14
<b>Andes CA18</b>	300	300	300 mm	8
<b>Carva CV1</b>	2500	600	400 mm	107
<b>Carva CVH1</b>	2500	750	450 mm	242

				KG
<b>Carpa CR1</b>	1150	1150	400 mm	60
<b>Carpa CR2</b>	1150	400	400 mm	45
<b>Carpa CR3</b>	2000	400	400 mm	72
<b>Carpa CRH1</b>	1300	1300	450 mm	103
<b>Carpa CRH2</b>	1150	550	450 mm	75
<b>Carpa CRH3</b>	2000	550	450 mm	122

			KG
<b>Cado CC1</b>	1000	800 mm	62
<b>Cado CC2</b>	800	800 mm	47
<b>Cado CC3</b>	600	600 mm	28
<b>Cado CC4</b>	500	500 mm	14
<b>Cado CC5</b>	400	400 mm	11
<b>Cado CC6</b>	300	300 mm	7

<b>Celso CS1</b>	1500	1500 mm	145
<b>Celso CS2</b>	1200	1200 mm	90
<b>Celso CS3</b>	1000	1000 mm	59
<b>Celso CS4</b>	800	800 mm	25

<b>Atlas CT1</b>	1000	1000 mm	69
<b>Atlas CT2</b>	800	800 mm	45
<b>Atlas CT3</b>	600	600 mm	26

Aluminium



Fuß  
15 mm

Material  
3 mm



## Aluminium

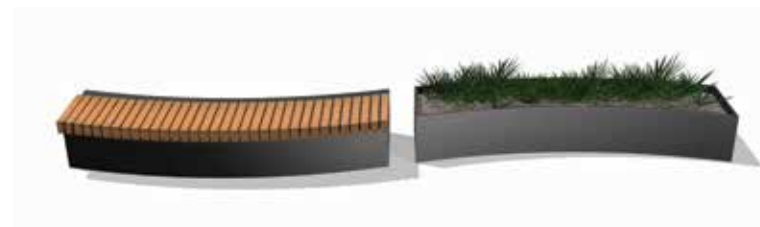
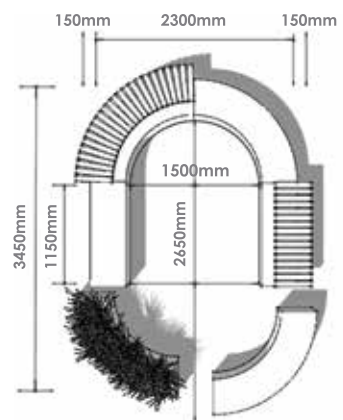

Alva



Florida



Sydney



Cairo



Alma



Alma mit Padouk Sitzelement

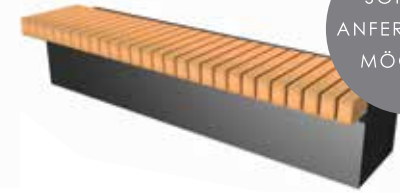



Alma mit Padouk Sitzelement

SONDER-  
ANFERTIGUNG  
MÖGLICH

Aluminium

				KG
Florida AF1	1400	1400	800 mm	58
Florida AF2	1200	1200	800 mm	47
Florida AF3	1000	1000	1000 mm	45
Florida AF4	1000	1000	800 mm	38
Florida AF4.1	1000	1000	600 mm	30
Florida AF5	800	800	800 mm	29
Florida AF5.1	800	800	600 mm	23
Florida AF6	700	700	700 mm	22
Florida AF7	600	600	600 mm	16
Florida AF8	500	500	500 mm	12
Florida AF9	2000	500	600 mm	37
Florida AF10	1500	500	600 mm	29
Florida AF11	1200	500	600 mm	24
Florida AF12	900	300	800 mm	20
Florida AF13	500	500	1000 mm	20
Florida AF14	400	400	1000 mm	16
Florida AF15	400	400	800 mm	13

				KG
Alma AR1	1150	1150	400 mm	28
Alma AR2	1150	400	400 mm	21
Alma AR3	2000	400	400 mm	34
Alma ARH1	1300	1300	450 mm	100
Alma ARH2	1150	550	450 mm	69
Alma ARH3	2000	550	450 mm	76

Alva AV1	2500	600	400 mm	51
Alva AVH1	2500	750	450 mm	186

Sydney AM1	1000	1000 mm	36
Sydney AM2	800	800 mm	24
Sydney AM3	600	600 mm	13

Cairo AC1	1000	800 mm	31
Cairo AC2	800	800 mm	23
Cairo AC3	600	600 mm	13

Burni

Burni



Material  
3 mm





### Burni Feuelemente

				KG
Skipp SKS1	410	460	1000 mm	41





### Burni Feuelemente

				KG
<b>Borr BRRS1-BRRG1</b>	500	500	2000 mm	168





Material  
3 mm



## Burni Feuelemente

**Burni** Die komplette BURNI® Collection wird aus 3 mm starkem CorTen Stahl gefertigt und jedes Modell kann mit einem BBQ Grill ausgestattet werden. Gegen einen geringen Aufpreis können alle BURNI®s mit einer schwarzen, hitzebeständigen Farbe beschichtet werden (nur geringer/kaum Rostschutz!). Auf alle Produkte der BURNI® -Serie gewähren wir 5 Jahre Garantie. Anzünden: Beginnen Sie immer mit kleinen Mengen feinem Anzündholz und befeuern Sie die Feuerstelle erst wenn das Feuer deutlich brennt mit größeren Scheiten. Stellen Sie immer sicher, dass das Feuer genügend Sauerstoff bekommt. Bitte beachten Sie, dass die Außenseite der Feuerstellen sehr heiß werden kann – Verbrennungsgefahr! Alle CorTen Stahlprodukte werden unberostet ausgeliefert. Die CorTen Stahloptik entsteht bei normaler Bewitterung langsam innerhalb von 4-5 Monaten: Bis zur dann versiegelten Oberfläche kann es zu Verfärbungen/ Rostspuren am Aufstellungsort kommen.



Arvid







Stig

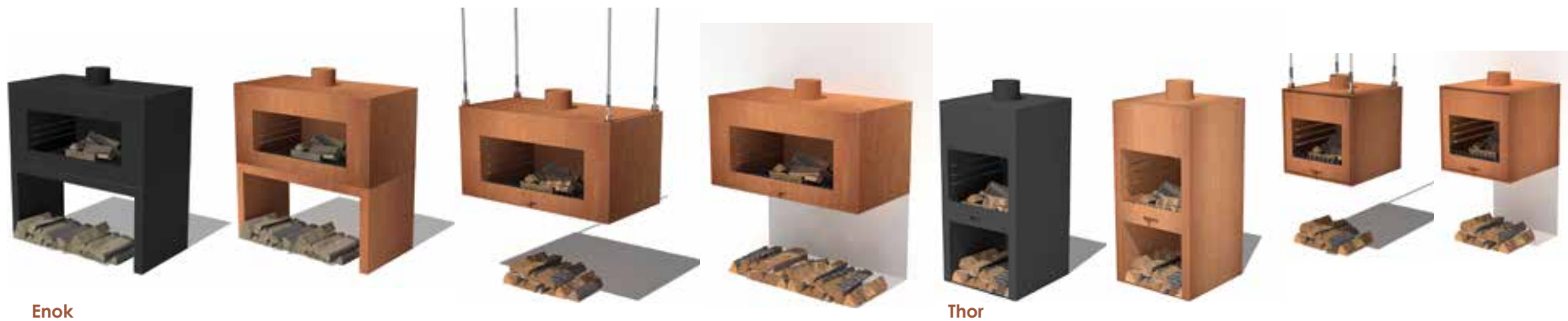

Arkin - Jari - Tyr





				KG
<b>Arvid BDS1 - BDG1</b>	500	500	1000 mm	77

<b>Stig BGS1 - BGG1</b>	500	500	1000 mm	79
<b>Stig L BGS2 - BGG2</b>	850	500	1200 mm	110

<b>Enok BK2SA - BK2GA</b>	1000	500	1000 mm	99
<b>Enok wand BKWS1 - BKWG1</b>	1000	500	500 mm	77
<b>Enok hängen BKHS1 - BKHG1</b>	1000	500	500 mm	77
<b>Enok tor BKDS1 - BKDG1</b>	780	10	350 mm	11

<b>Thor BR2SA - BR2GA</b>	550	500	1050 mm	75
<b>Thor wand BRWS1 - BRWG1</b>	550	500	550 mm	58
<b>Thor hängen BRHS1 - BRHG1</b>	550	500	550 mm	58
<b>Thor tor BRDS1 - BRDG1</b>	480	10	350 mm	8

<b>Arkin BVS1 - BVG1</b>	400	400	1000 mm	45
<b>Jari BVS2 - BVG2</b>	400	400	1000 mm	45
<b>Tyr BVS3 - BVG3</b>	400	400	1000 mm	45



Arkin



Jari



Tyr

Alle Accessoires werden von uns selbst gefertigt. Bitte beachten Sie die Seite 24-25



Material  
3 mm



## Burni Feuelemente

**Burni:** Die komplette BURNI® Collection wird aus 3 mm starkem CorTen Stahl gefertigt und jedes Modell kann mit einem BBQ Grill ausgestattet werden. Gegen einen geringen Aufpreis können alle BURNI®s mit einer schwarzen, hitzebeständigen Farbe beschichtet werden (nur geringer/kaum Rostschutz!). Auf alle Produkte der BURNI® -Serie gewähren wir 5 Jahre Garantie. Anzünden: Beginnen Sie immer mit kleinen Mengen feinem Anzündholz und befeuern Sie die Feuerstelle erst wenn das Feuer deutlich brennt mit größeren Scheiten. Stellen Sie immer sicher, dass das Feuer genügend Sauerstoff bekommt. Bitte beachten Sie, dass die Außenseite der Feuerstellen sehr heiß werden kann – Verbrennungsgefahr! Alle CorTen Stahlprodukte werden unberostet ausgeliefert. Die CorTen Stahloptik entsteht bei normaler Bewitterung langsam innerhalb von 4-5 Monaten: Bis zur dann versiegelten Oberfläche kann es zu Verfärbungen/Rostspuren am Aufstellungsort kommen.



Holzlager BHS1 - BHG1



Thermo Esche Sitzelement BHS2H- BHG2H



Verknüpfbare Holzlager

				KG
<b>Holzlager BHS1 - BHG1</b>	1000	400	1800 mm	72
<b>Holzlager BHS2H – BHG2H</b>	2000	400	430 mm	80
<b>Verknüpfbare Holzlager BHS3</b>	485	250	485 mm	7,5



Material  
3 mm



## Burni Feuelemente

**Burni:** Die komplette BURNI® Collection wird aus 3 mm starkem CorTen Stahl gefertigt und jedes Modell kann mit einem BBQ Grill ausgestattet werden. Gegen einen geringen Aufpreis können alle BURNI®s mit einer schwarzen, hitzebeständigen Farbe beschichtet werden (nur geringer/kaum Rostschutz!). Auf alle Produkte der BURNI® -Serie gewähren wir 5 Jahre Garantie. Anzünden: Beginnen Sie immer mit kleinen Mengen feinem Anzündholz und befeuern Sie die Feuerstelle erst wenn das Feuer deutlich brennt mit größeren Scheiten. Stellen Sie immer sicher, dass das Feuer genügend Sauerstoff bekommt. Bitte beachten Sie, dass die Außenseite der Feuerstellen sehr heiß werden kann – Verbrennungsgefahr! Alle CorTen Stahlprodukte werden unberostet ausgeliefert. Die CorTen Stahloptik entsteht bei normaler Bewitterung langsam innerhalb von 4-5 Monaten: Bis zur dann versiegelten Oberfläche kann es zu Verfärbungen/Rostspuren am Aufstellungsort kommen.



Feuerschalen



Feuertisch Rund VLS1 + 2





Gusstahl BRCA



Foc 1





Feuertisch quadratisch VLS3 + VLS4

			KG
<b>Feuerschalen BNS1</b>	600	140 mm	10
<b>Feuerschalen BNS2</b>	800	210 mm	17
<b>Feuerschalen BNS3</b>	1000	210 mm	25
<b>Feuerschalen BNS4</b>	1200	210 mm	30
<b>Feuerschalen BNS5</b>	1500	330 mm	68

<b>Feuertisch VLS1</b>	1250	280 mm	59
<b>Feuertisch VLS2</b>	1750	280 mm	102

<b>Borc BRCA</b>	1350	100 mm	75
------------------	------	--------	----

<b>Foc 1 DNS1</b>	600	250 mm	20
<b>Foc 2 DSN4</b>	1200	380 mm	60

				KG
<b>Feuertisch VLS3</b>	1200	1200	280 mm	76
<b>Feuertisch VLS4</b>	1400	1400	280 mm	96



**Accessoires Burni:** Alle unsere Zubehörteile entsprechen den höchsten Standards und passen perfekt zu unseren Produkten. Die Ofenrohre sind aus 2mm Stahl produziert.



Pizzastein Cordierit | Rauchrohre (2mm) L. 1000 + 750 + 500 mm, 45 + 90 ° (Schwarz & Corten) | Regenkappe (2 mm, schwarz & Corten) | Wandhalterung (schwarz & Corten)



**Accessoires Burni:** Alle unsere Zubehörteile entsprechen den höchsten Standards und passen perfekt zu unseren Produkten.





Das Modell THOR kann einfach mit einer Klappe (an neuen und bestehenden Öfen) ausgerüstet werden.





Das Modell ENOK kann einfach mit einer Klappe (an neuen und bestehenden Öfen) ausgerüstet werden.

				KG
<b>BRDS1 THOR</b>	480	10	350 mm	4
<b>BRDG1 THOR Beschichtung RAL 9005</b>	480	10	350 mm	4

<b>BKDS1 ENOK</b>	780	10	350 mm	5
<b>BKDG1 ENOK Beschichtung RAL 9005</b>	780	10	350 mm	5





Aluminium  
4 mm

Corten steel  
3 mm

## Wasserelemente

**Wasserelemente** Mit unseren Wasserelementen gestalten Sie Oasen in den Gärten Ihrer Kunden. Die Vielfalt an Designs, Formen und Farben ist enorm. Wir führen runde, quadratische und rechteckige Formen, Modelle mit Wasserfall, wahlweise auch mit LED Beleuchtung. Wasserwände können freistehend am Teichbecken, im Teichbecken integriert aber auch einzeln bestellt werden. Aluminium Wasserelemente sind in vielen RAL Farben erhältlich.

Jeder Teich hat standardmäßig zwei 1-Zoll-Anschlüsse und ein Überlaufrohr, welches leicht entfernt werden kann. Auf unserer Webseite können Sie die Aufbauanleitung und technische Zeichnungen downloaden.

				KG
<b>Aluminium Teich VA1</b>	3000	2000	600 mm	146
<b>Aluminium Teich VA2</b>	3000	1500	600 mm	122
<b>Aluminium Teich VA3</b>	2500	1250	600 mm	95

<b>Teichmauer am Teich VM1</b>	2000	250	600 mm	40
<b>Teichmauer am Teich VM2</b>	2500	250	600 mm	49
<b>Teichmauer am Teich VM3</b>	3000	250	600 mm	58
<b>Teichmauer freistehend VM4</b>	2000	250	1200 mm	52
<b>Teichmauer freistehend VM5</b>	2500	250	1200 mm	64
<b>Teichmauer freistehend VM6</b>	3000	250	1200 mm	72

<b>CorTen Stahl Teich VC1</b>	3000	2000	600 mm	319
<b>CorTen Stahl Teich VC2</b>	3000	1500	600 mm	266
<b>CorTen Stahl Teich VC3</b>	2500	1250	600 mm	206

<b>Teichmauer am Teich VCM1</b>	2000	250	600 mm	76
<b>Teichmauer am Teich VCM2</b>	2500	250	600 mm	93
<b>Teichmauer am Teich VCM3</b>	3000	250	600 mm	109
<b>Teichmauer freistehend VCM4</b>	2000	250	1200 mm	98
<b>Teichmauer freistehend VCM5</b>	2500	250	1200 mm	120
<b>Teichmauer freistehend VCM6</b>	3000	250	1200 mm	142



Aluminium Teich

Teichmauer am Teich

Teichmauer freistehend





Corten Teich

Teichmauer am Teich

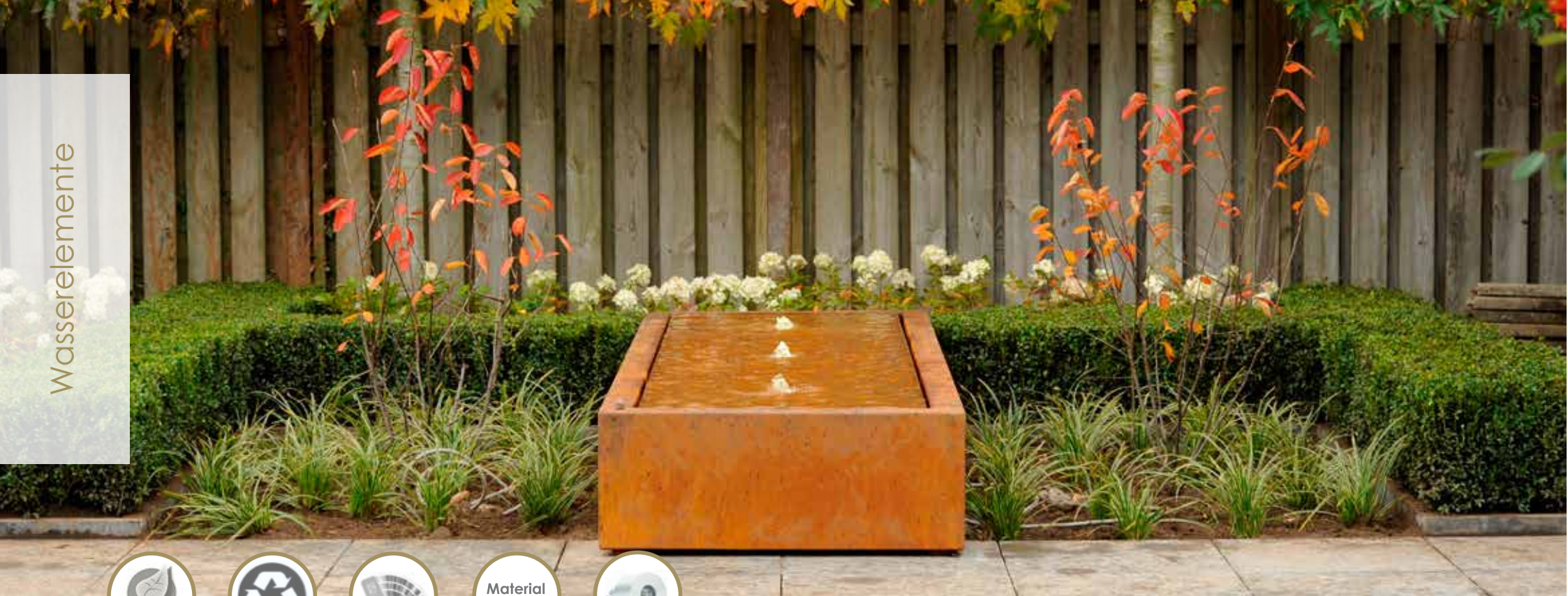
Teichmauer freistehend



**Wasserelemente** Wassertische: Lieferung mit LED und Pumpe inkl.



			KG
<b>WNG1 Beschichtung DB703</b>	600	210 mm	10
<b>WNG2 Beschichtung DB703</b>	800	210 mm	17
<b>WNG3 Beschichtung DB703</b>	1000	210 mm	25
<b>WNG4 Beschichtung DB703</b>	1200	210 mm	30
<b>WNG5 Beschichtung DB703</b>	1500	330 mm	68
<b>WNS1 CorTen Stahl</b>	600	210 mm	10
<b>WNS2 CorTen Stahl</b>	800	210 mm	17
<b>WNS3 CorTen Stahl</b>	1000	210 mm	25
<b>WNS4 CorTen Stahl</b>	1200	210 mm	30
<b>WNS5 CorTen Stahl</b>	1500	330 mm	68



WNG1-5





WNS1-5

				KG
<b>AB4 Aluminium 7021 3 brunnen</b>	3000	1000	400 mm	94
<b>AB5 Aluminium 7021 4 brunnen</b>	4000	1000	400 mm	121
<b>AB6 Aluminium 7021 6 brunnen</b>	6000	1000	400 mm	180

<b>CB4 CorTen Stahl 3 brunnen</b>	3000	1000	400 mm	125
<b>CB5 CorTen Stahl 4 brunnen</b>	4000	1000	400 mm	256
<b>CB6 CorTen Stahl 6 brunnen</b>	6000	1000	400 mm	375

<b>AB1 Alu Beschichtung 7021</b>	1200	1200	400 mm	50
<b>AB2 Alu Beschichtung 7021</b>	1000	1000	400 mm	36
<b>AB3 Alu Beschichtung 7021</b>	800	800	400 mm	26

<b>CB1 CorTen Stahl</b>	1200	1200	400 mm	95
<b>CB1 CorTen Stahl</b>	1000	1000	400 mm	70
<b>CB3 CorTen Stahl</b>	800	800	400 mm	50

			KG
<b>ABR1</b>	1500	750 mm	59
<b>ABR2</b>	1200	750 mm	43
<b>ABR3</b>	1000	750 mm	33

<b>CBR1</b>	1500	750 mm	170
<b>CBR2</b>	1200	750 mm	123
<b>CBR3</b>	1000	750 mm	95

<b>WBS4</b>	1800	450 mm	350
-------------	------	--------	-----

<b>WBS5</b>	2350	600 mm	500
-------------	------	--------	-----



AB4-6



CB4-6

neu



AB1-3



CB1-3



ABR1-3



CBR1

neu



WBS4 polymerbeton



WBS5 polymerbeton

neu

Wasserelemente

# Polymerbeton

Material  
23 mm

Standard  
Farbe  
7021+7035

## Polymerbeton

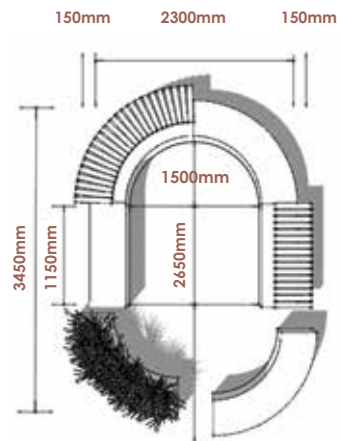

Banni

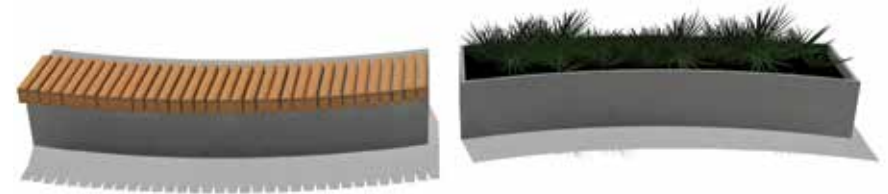

Bosco



**Banni mit Padouk Sitzelement**





**Bosco mit Padouk Sitzelement**



**Banni**



**Banco**

				KG
<b>Banni BA1 Quadrant</b>	1150	1150	400 mm	114
<b>Banni BA2</b>	1150	400	400 mm	90
<b>Banni BA3</b>	2000	400	400 mm	151
<b>Banni BAH1 Quadrant</b>	1300	1300	450 mm	150
<b>Banni BAH2</b>	1150	550	450 mm	115
<b>Banni BAH3</b>	2000	550	450 mm	187

<b>Bosco BC1</b>	2500	740	450 mm	298
<b>Bosco BCH1</b>	2500	600	400 mm	244

<b>Banco</b>	Verfügbar in 23 Größen
--------------	------------------------

Polymerbeton Gefäße sind wasserdicht und werden im Standard ohne Loch geliefert.

Polymerbeton



Material  
23 mm

Standard  
Farbe  
7021+7035

### Polymerbeton

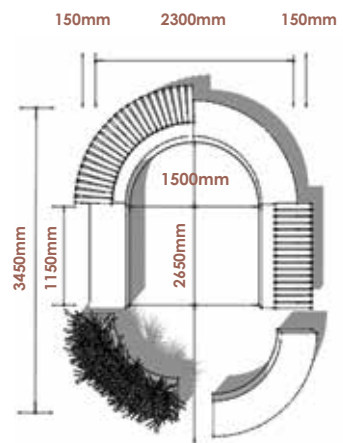

Banni

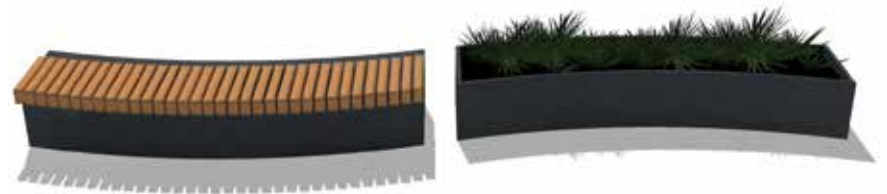

Bosco





**Banni mit Padouk Sitzelement**





**Banni mit Padouk Sitzelement**



**Bosco**



**Banco**

				KG
<b>Banni BA1 Quadrant</b>	1150	1150	400 mm	112
<b>Banni BA2</b>	1150	400	400 mm	90
<b>Banni BA3</b>	2000	400	400 mm	145
<b>Banni BAH1 Quadrant</b>	1300	1300	450 mm	150
<b>Banni BAH2</b>	1150	550	450 mm	115
<b>Banni BAH3</b>	2000	550	450 mm	187

<b>Bosco BC1</b>	2500	600	400 mm	208
<b>Bosco BCH1</b>	2500	740	450 mm	276

<b>Banco</b>	Verfügbar in 23 Größen
--------------	------------------------

Polymerbeton Gefäße sind wasserdicht und werden im Standard ohne Loch geliefert.

Polymerbeton



Material  
23 mm

Standard  
Farbe  
7021 + 9010

Polymerbeton



Buzz



Besso



Besso



Picasso



Barro



Bodil mit 60mm FüÙe



**Buzz**

**Besso**

**Besso**

**Picasso**

**Barro**

**Bodil mit 60mm Füße**

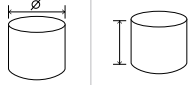
		KG
<b>Buzz BZ1</b>	1800 580 mm	367
<b>Buzz BZ2</b>	2350 755 mm	640

<b>Besso BS1</b>	2000 340 mm	269
<b>Besso BS2</b>	1500 340 mm	125
<b>Besso BS4</b>	1800 450 mm	350
<b>Besso BS5</b>	2350 600 mm	490

<b>Besso BS3</b>	2200 400 mm	404
------------------	-------------	-----

<b>Picasso BP1</b>	1000 600 mm	120
<b>Picasso BP2</b>	600 900 mm	70



<b>Barro BR1</b>	1200 900 mm	231
<b>Barro BR2</b>	1500 1200 mm	408

<b>Bodil BD1</b>	1800 400 mm	378
<b>Bodil BD2</b>	2350 400 mm	587



### Blockwände CorTen Stahl

**Blockwände CorTen Stahl** Blockwände aus CorTen Stahl schaffen interessante Hintergründe im Garten. Zu verwenden als dekorative Wand, oder zusätzlich mit integriertem Kamin und Holzlager. Die einzelnen Elemente können miteinander verbunden werden, um auch größere Abschnitte zu gestalten.

				KG
<b>CBW1</b>	1950	1950	100 mm	110
<b>CBW2</b>	1950	1950	500 mm	130
<b>CBW3</b>	1950	1950	500 mm	160

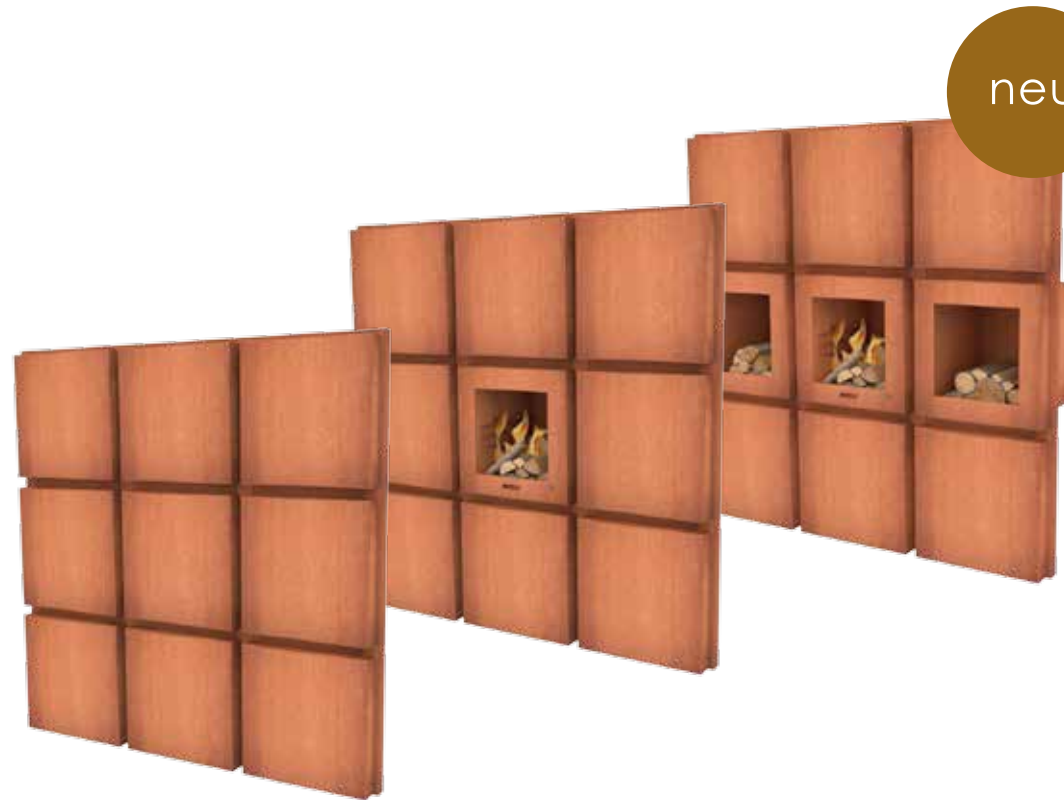

neu

Blockwände

CBW1 nur Blöcke



CBW2 mit Blöcke und Feuerstelle

CBW3 mit Blöcke, Feuerstelle und Holzlager





## Sockel

**Sockel** Wir produzieren solide U-förmige Sockel, auf denen Sie Objekte bis zu einem Gewicht von bis zu 150 kg platzieren können. Diese Sockel (U-Block) können gleichzeitig als Holzlager genutzt werden.

				KG
<b>CK1</b>	500	500	1200 mm	42
<b>CK2</b>	500	500	1000 mm	36
<b>CK3</b>	500	500	800 mm	29
<b>CK4</b>	500	500	600 mm	23
<b>CK5</b>	400	400	1200 mm	33
<b>CK6</b>	400	400	1000 mm	28
<b>CK7</b>	400	400	800 mm	23
<b>CK8</b>	400	400	600 mm	18



Socket CorTen Stahl

				KG
<b>CKU1</b>	500	500	1200 mm	52
<b>CKU2</b>	500	500	1000 mm	44
<b>CKU3</b>	500	500	800 mm	37
<b>CKU4</b>	500	500	600 mm	29
<b>CKU5</b>	400	400	1200 mm	41
<b>CKU6</b>	400	400	1000 mm	35
<b>CKU7</b>	400	400	800 mm	29
<b>CKU8</b>	400	400	600 mm	23



Socket U block CorTen Stahl





## Wände CorTen Stahl

**Wände CorTen Stahl** Neu im Programm sind Wände aus CorTen Stahl: Extrem solide Wände, mit denen Sie schnell Abtrennungen, Sichtschutz oder spannende Durchblicke erstellen können. Die Wände können sehr einfach auf frostsichere Fundamente oder feste, tragfähige Bodenplatten verschraubt werden. In den hohlen Korpus der Wände können Sie einfach Beleuchtung etc. einbauen.

Vorteile von CorTen Stahlwänden:

- Kostengünstiger als vergleichbare Wände
- Sehr solides und dauerhaftes Material
- Große gestalterische Freiheit
- Natürliche Optik
- Maßanfertigungen möglich
- Einfache Selbstmontage von z.B. Beleuchtung möglich.



				KG
<b>CW1</b>	6000	150	1350 mm	290
<b>CW2</b>	6000	150	1000 mm	221
<b>CW3</b>	6000	150	800 mm	181
<b>CW4</b>	4000	150	1350 mm	205
<b>CW5</b>	4000	150	1000 mm	149
<b>CW6</b>	4000	150	800 mm	122
<b>CW7</b>	3000	150	1350 mm	149
<b>CW8</b>	3000	150	1000 mm	113
<b>CW9</b>	3000	150	800 mm	93
<b>CW10</b>	2000	150	1350 mm	101
<b>CW11</b>	2000	150	1000 mm	77
<b>CW12</b>	2000	150	800 mm	64
<b>CW13</b>	1000	150	2000 mm	78
<b>CW14</b>	1000	150	1350 mm	54
<b>CW15</b>	1000	150	1000 mm	41
<b>CW16</b>	1000	150	800 mm	34



Wände Corten Stahl





## Wände Fiberglas

**Wände Fiberglas** Neu im Programm sind Wände aus Polyester: Sehr stabile und leichte Wände, mit denen Sie schnell Abtrennungen, Sichtschutz oder überraschende Durchblicke erstellen können. Die Wände können sehr einfach auf frostsichere Fundamente oder feste, tragfähige Bodenplatten verschraubt werden. In den hohlen Korpus der Wände können Sie einfach Beleuchtung etc. einbauen.

Vorteile von Polyesterwänden:



- Kostengünstiger als vergleichbare Wände
- Geringes Gewicht
- Sehr solider Faserverbundstoff
- Einfach zu pflegen
- Erhältlich in 10 RAL Farben
- Einfache Selbstmontage von z.B. Beleuchtung möglich

Wir empfehlen die Wände mindestens zweimal pro Jahr mit unserem Polyester Pflege-Set zu reinigen. Verwenden Sie bitte keinen Hochdruckreiniger und keine scheuernden oder lösungsmittelhaltigen Reinigungsmittel. Wir empfehlen zur Reinigung einen Glasreiniger mit Wasser.

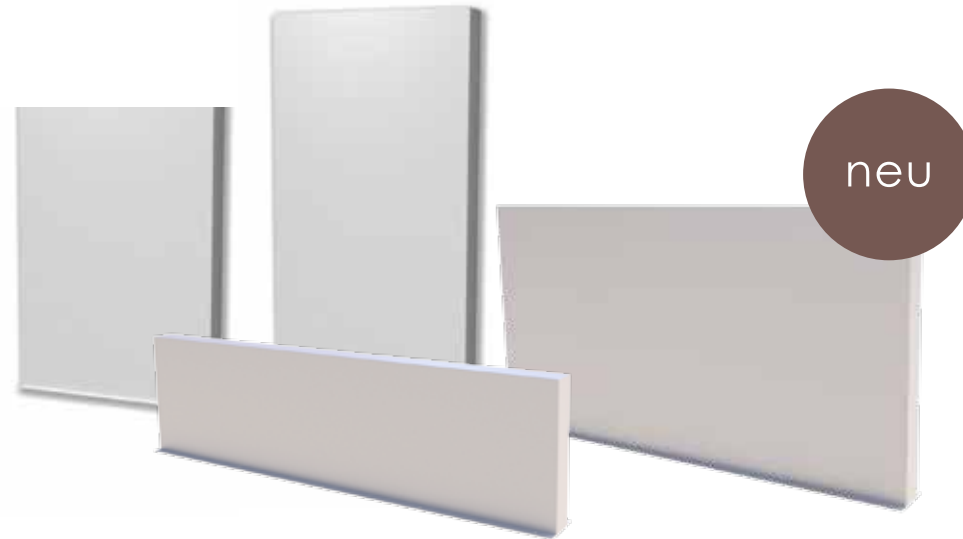
				KG
<b>PW1</b>	6000	150	2000 mm	145
<b>PW2</b>	6000	150	1500 mm	112
<b>PW3</b>	6000	150	1000 mm	78
<b>PW4</b>	4000	150	800 mm	64
<b>PW5</b>	4000	150	2000 mm	98
<b>PW6</b>	4000	150	1500 mm	75
<b>PW7</b>	3000	150	1000 mm	53
<b>PW8</b>	3000	150	800 mm	43
<b>PW9</b>	3000	150	2000 mm	75
<b>PW10</b>	3000	150	1500 mm	57
<b>PW11</b>	3000	150	1000 mm	40
<b>PW12</b>	3000	150	800 mm	33
<b>PW13</b>	2000	150	2000 mm	51
<b>PW14</b>	2000	150	1350 mm	39
<b>PW15</b>	2000	150	1000 mm	27
<b>PW16</b>	2000	150	800 mm	23
<b>PW17</b>	1000	150	2000 mm	27
<b>PW18</b>	1000	150	1500 mm	21
<b>PW19</b>	1000	150	1000 mm	15
<b>PW20</b>	1000	150	800 mm	12



Wände Fiberglas

				LED LIGHT
<b>LW1</b>	140	71	70 mm	Aluminum + led
<b>LW2</b>	90	71	90 mm	Aluminum + led
<b>LW3</b>	Ø 80 mm			Aluminum + led







## Briefkästen

**Briefkästen** Zwei zeitlose Modelle von Briefkästen sind Bestandteil unseres Programms - wahlweise in CorTen Stahl oder aus pulverbeschichtetem Aluminium gefertigt. Alle Briefkästen besitzen auf der Rückseite eine verschließbare Tür und werden mit zwei Schlüsseln geliefert. Hausnummern und Buchstaben können aus gleichem Material mitbestellt werden. Aus Aluminium gefertigte Kästen können in vielen RAL-Farben geliefert werden.



**Hacon**

**Ivar**

				KG
<b>Hacon HAC1</b>	300	300	1200 mm	25
<b>Hacon HAA1</b>	300	300	1200 mm	14



<b>Ivar IVC1</b>	300	300	1200 mm	25
<b>Ivar IVA1</b>	300	300	1200	14

Buchstaben und Zahlen sind in CorTen Stahl und Edelstahl erhältlich: 0, 1, 2, 3, 4, 5, 6, 7, 8, 9, a, b, c, d



## CorTen Treppen

**CorTen Treppen** Wir fertigen für Sie Treppen aus CorTen Stahl im Stück, mit denen Sie sehr einfach Höhendifferenzen im Garten ausgleichen können. Die Breite der Treppe kann von 750 mm bis 3000 mm betragen, die Stufenhöhe beträgt 170 mm, maximale Stufenanzahl 15.

				KG
<b>CST1</b>	1000	480	340 mm	42
<b>CST2</b>	1500	480	340 mm	63
<b>CST3</b>	3000	480	340 mm	126
<b>CST4</b>	1000	960	680 mm	84
<b>CST5</b>	1500	960	680 mm	126
<b>CST6</b>	3000	960	680 mm	252
<b>CST7</b>	1000	1440	1020 mm	126
<b>CST8</b>	1500	1440	1020 mm	189
<b>CST9</b>	3000	1440	1020 mm	378

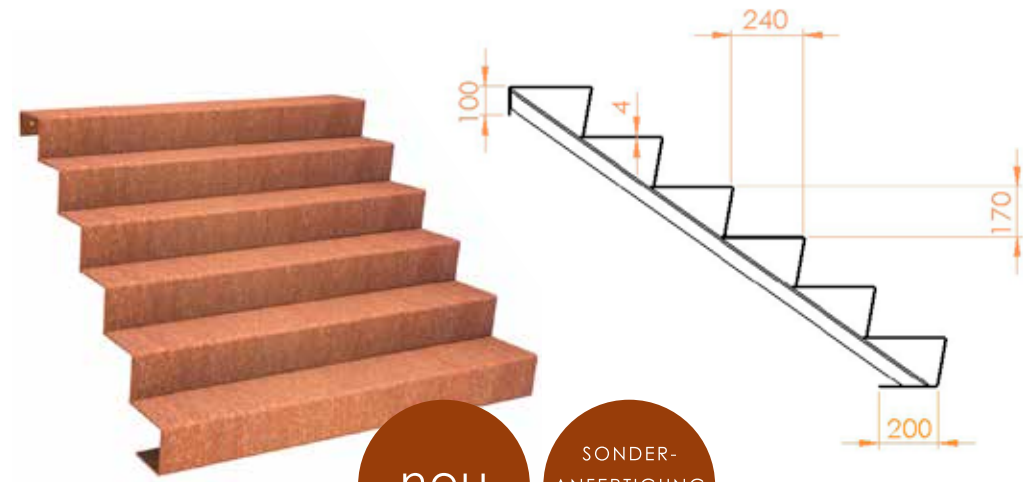

CorTen Stahl Treppe 4 mm

neu

SONDER-  
ANFERTIGUNG  
MÖGLICH







Corten Treppen



## Beeteinfassungen

**Beeteinfassungen** Beeteinfassungen definieren Bereiche und erleichtern die Pflege. Wir produzieren Einfassungen aus CorTen Stahl und verzinktem Stahl in zwei Höhen: 150 mm und 290 mm. Die Materialstärke beträgt wahlweise 2 mm oder 3 mm. Die Länge der Einfassungen beträgt 2500 mm. Jeweils drei verschiedene Kantenabschlüsse stehen wahlweise zur Verfügung: Einfach geschnittene Kante, 90 Grad gekantet oder 180 Grad doppelt gekantet.



		Maße Gerade	Maße Ecke innen + außen	Höhen	Material	90 Grad	180 Grad
	<b>Einfassung CR Gerade</b>	2500 x 150mm 2500 x 290mm	300 x 300 mm	150mm, 290mm	CorTen Stahl 2mm, 3mm		
	<b>Einfassung CZ 90 Grad gekantet</b>	2500 x 150mm 2500 x 290mm	300 x 300 mm	150mm, 290mm	CorTen Stahl 2mm, 3mm	30mm	
	<b>Einfassung CP 180 Grad doppelt gekantet</b>	2500 x 150mm 2500 x 290mm	300 x 300 mm	150mm, 290mm	CorTen Stahl 2mm, 3mm		15mm
	<b>Einfassung VZ Gerade</b>	2500 x 150mm 2500 x 290mm	300 x 300 mm	150mm, 290mm	Galvanisierter Stahl 2mm, 3mm		
	<b>Einfassung VZ 90 Grad gekantet</b>	2500 x 150mm 2500 x 290mm	300 x 300 mm	150mm, 290mm	Galvanisierter Stahl 2mm, 3mm	30mm	
	<b>Einfassung VP 180 Grad doppelt gekantet</b>	2500 x 150mm 2500 x 290mm	300 x 300 mm	150mm, 290mm	Galvanisierter Stahl 2mm, 3mm		15mm
	<b>Pfosten</b>	siehe Zubehör					



**Accessoires** Alle unsere Zubehörteile entsprechen den höchsten Standards und passen perfekt zu unseren Produkten.



Polyester Pflegeset



Aluminium Reiniger



Hitzebeständige Farbe



CorTen Versiegelung



Überlaufrohr



**Rollen 1100 KG**



**Rollen 450 KG**



**Pfosten PK**



**Verzinkte Stahlgestelle**

POL Polyester Pflegeset: Polyester Cleaner + Polyester Protector
Aluminium Reiniger 600ml.
Hitzebeständige Farbe 400m Schwarz Metallic
COR CorTen Versiegelung Owatrol 0.5 ltr. Owatrol 5.0 ltr.
Überlaufrohr Ø22mm x H. 50mm
Rollen Tragkraft 450 kg (4 Stück)
Rollen Tragkraft 1100 kg (4 Stück)
Pk 1 / 40x40x400 mm ( 25 Stück ) PK 2 / 40x40x600 mm ( 25 Stück )
10. Verzinkter Stahlgestelle, Fuß 90mm
OS01 Pflanzgefäße 1200x1200 mm
OS02 Pflanzgefäße 1000x1000 mm
OS03 Pflanzgefäße 800x800 mm
OS04 Pflanzgefäße 700x700 mm
OS05 Pflanzgefäße 600x600 mm
OS06 Pflanzgefäße 2000x500 mm
OS07 Pflanzgefäße 1500x500 mm
OS08 Pflanzgefäße 1200x500 mm



## Accessoires Wasserelemente



OASE PONTEC pump



OASE LED Wasserfall



OASE LED Wassertisch



**Wasserfall 3 Röhren**



**Wasserfall 60cm**



**Wasserfall 150cm**

VB1	Wasserfall 600 (Abfluss 50mm)	Edelstahl
VB2	Wasserfall 600 (Abfluss 150mm)	Edelstahl
VB3	Wasserfall 1500 (Abfluss 50mm)	Edelstahl
VB4	Wasserfall 1500 (Abfluss 150mm)	Edelstahl
VB5	Wasserfall 930 (Abfluss 3 Röhren 200mm)	Edelstahl
VB6	LED 600mm	
VB7	LED 1500mm	
VP2	Eco Pump 3500(50W) mit Schlauch	Fiberglas
VP3	Eco Pump 5000(60W) mit Schlauch	Fiberglas
VP5	Eco Pump 17000(180W) mit Schlauch	Fiberglas